



Driving Human Audio Experience

CORPORATE PRESENTATION

Italian Day in Frankfurt

25 January 2022



A WORLDWIDE LEADER IN PROFESSIONAL AMPLIFIERS

QUEEN ELISABETH HALL
ANTWERP



POWERSOFT AT A GLANCE

Powersoft is a global leader in **audio amplification technologies**, **advanced signal processing**, and **unique transducer systems** for the pro-audio sector

Powersoft specializes in the **design, production, and marketing of landmark products** for sophisticated customers and operators of the professional audio market. These products are the result of its strong emphasis on **R&D and continuous innovation**



Net Profit
€0.9m

25 Years
of Success



Revenues
€16.1m

4
Production
Plants*



~30
International
Patents

110
Headcounts



EBITDA Margin
13.4%

1H2021
FINANCIAL FIGURES

* 3 production plants are in outsourcing

A HISTORY OF CONSISTENT GROWTH



1995 - 1998

BIRTH AND DEVELOPMENT



Specialized in design, production and marketing of high-end patented technologies for professional audio applications

1998 - 2008

COMPANY GROWTH

2008 - 2018

CONSOLIDATION AND DIVERSIFICATION

TODAY

OVER 27 YEARS OF SUCCESS

DEC 17, 2018

IPO



AN ITALIAN EXCELLENCE POSITIONED AT THE HIGH-END PROFESSIONAL AUDIO MARKET

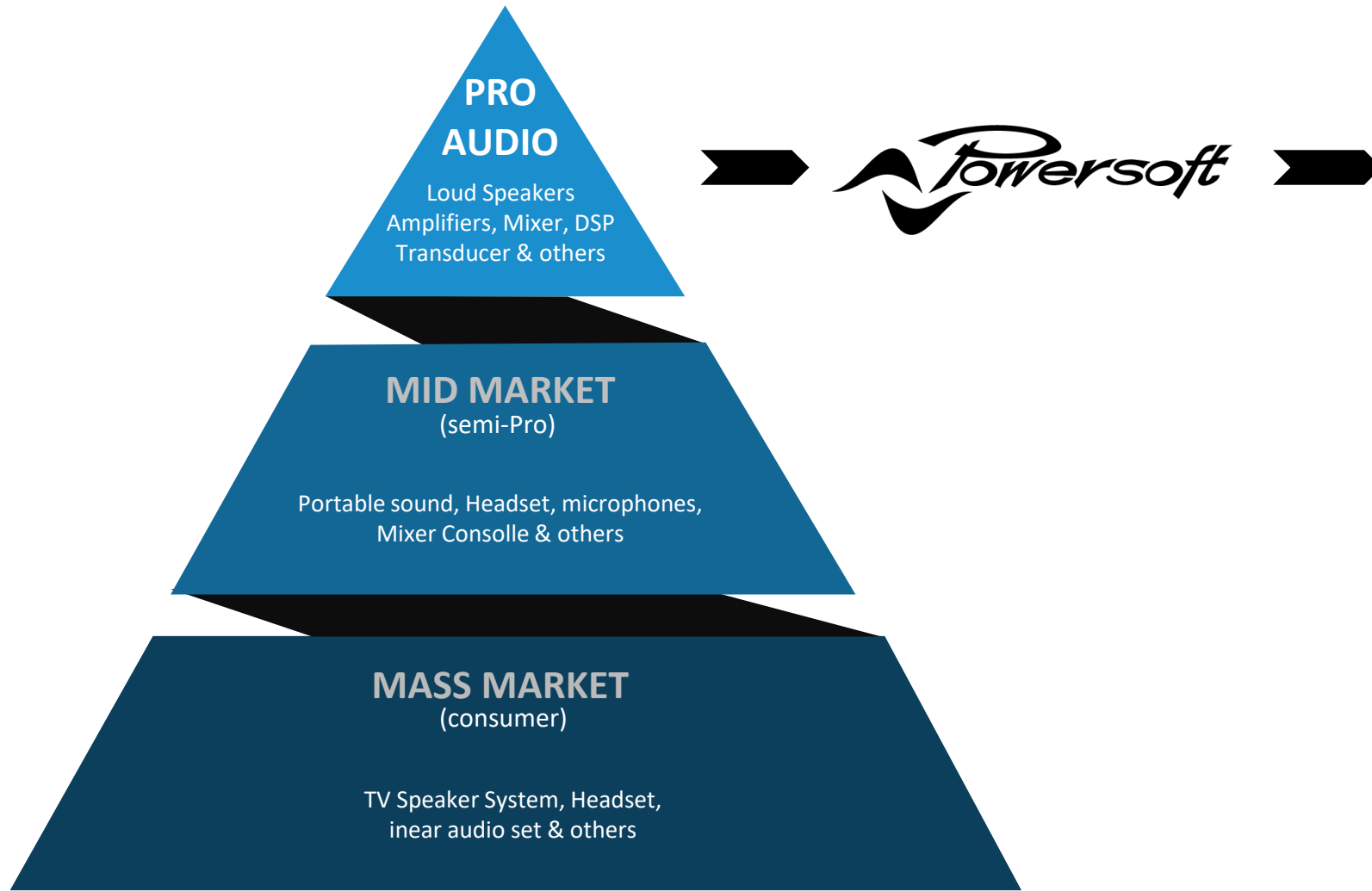

AT THE TOP OF THE PIRAMID

- A pioneer in the **high-end professional audio market**
- Globally recognized **market setter of unrivalled cutting-hedge products** in a thriving market
- Serving a broad range of clients, both **professional customers and audio-device makers**
- **Over 26 years as a forefront player in the market**, set to face future challenges and to exploit new opportunities



AT THE HEART OF THE PRO AUDIO SYSTEM

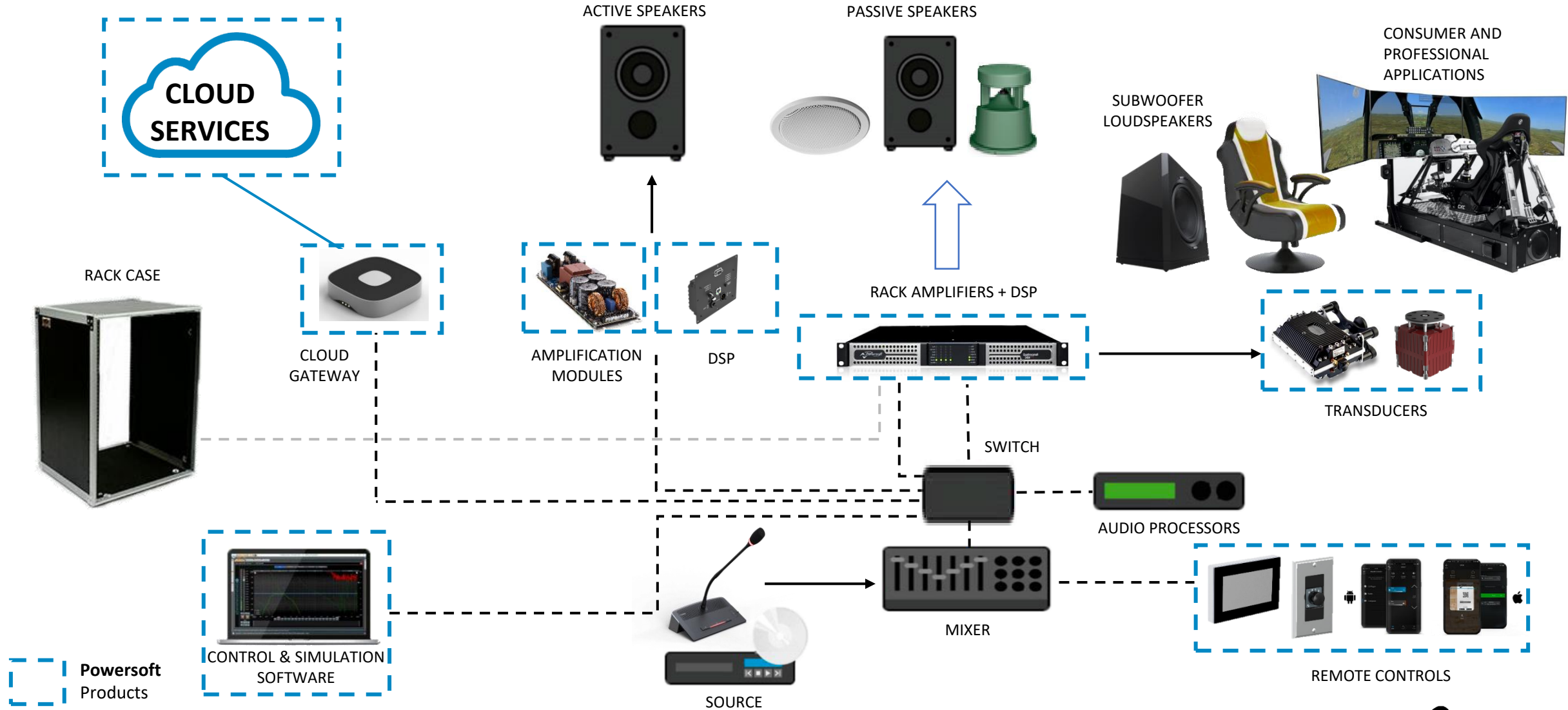

POWERSOFT AS PIONEER IN THE MARKET

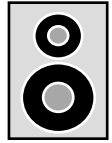

2005

AMPLIFICATION
MODULS

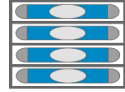

1995

Class D POWER AMPS



2021

SYSTEM SOLUTIONS

- Dynamic Music Distribution systems
- Multi channels amps for immersive systems



WHAT'S NEXT?



IMMERSIVE SOUND

PATENTED TECHNOLOGIES

- Innovative topologies for efficiency improvement in **switchmode power converters**
- **Control methods** for optimizing and compensating acoustical systems non linearities and enhancing global performances
- **Electromechanical conversion systems** for highly efficient and powerful acoustic transduction
- **Acoustical solutions** to increase compactness of acoustical cabinets and sound pressure level capabilities
- **Modular and flexible multichannel amplification platform** for large scale/channels count applications
- Efficient **Long Range Wireless Power Distribution** for domestic and commercial appliances
- **Self sufficient acoustical ambient enhancement**, for domestic and commercial applications



PRODUCTS AND SOLUTIONS VS MARKETS

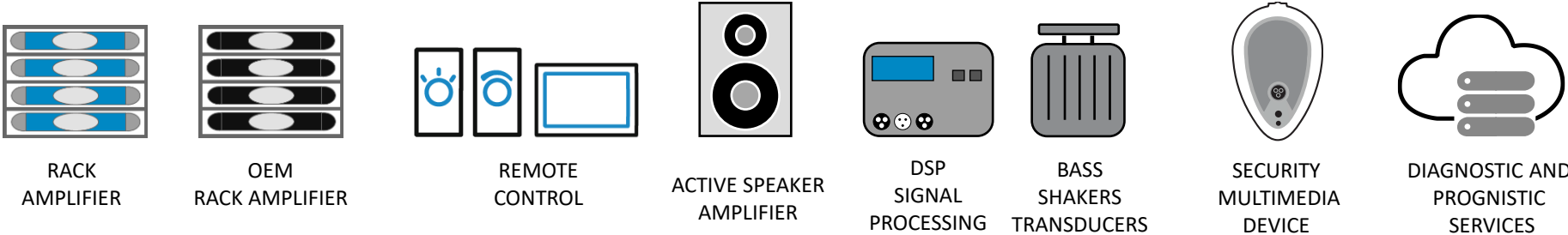

STRONG INTERNATIONAL PRESENCE

1H2021 REVENUES
BREAKDOWN

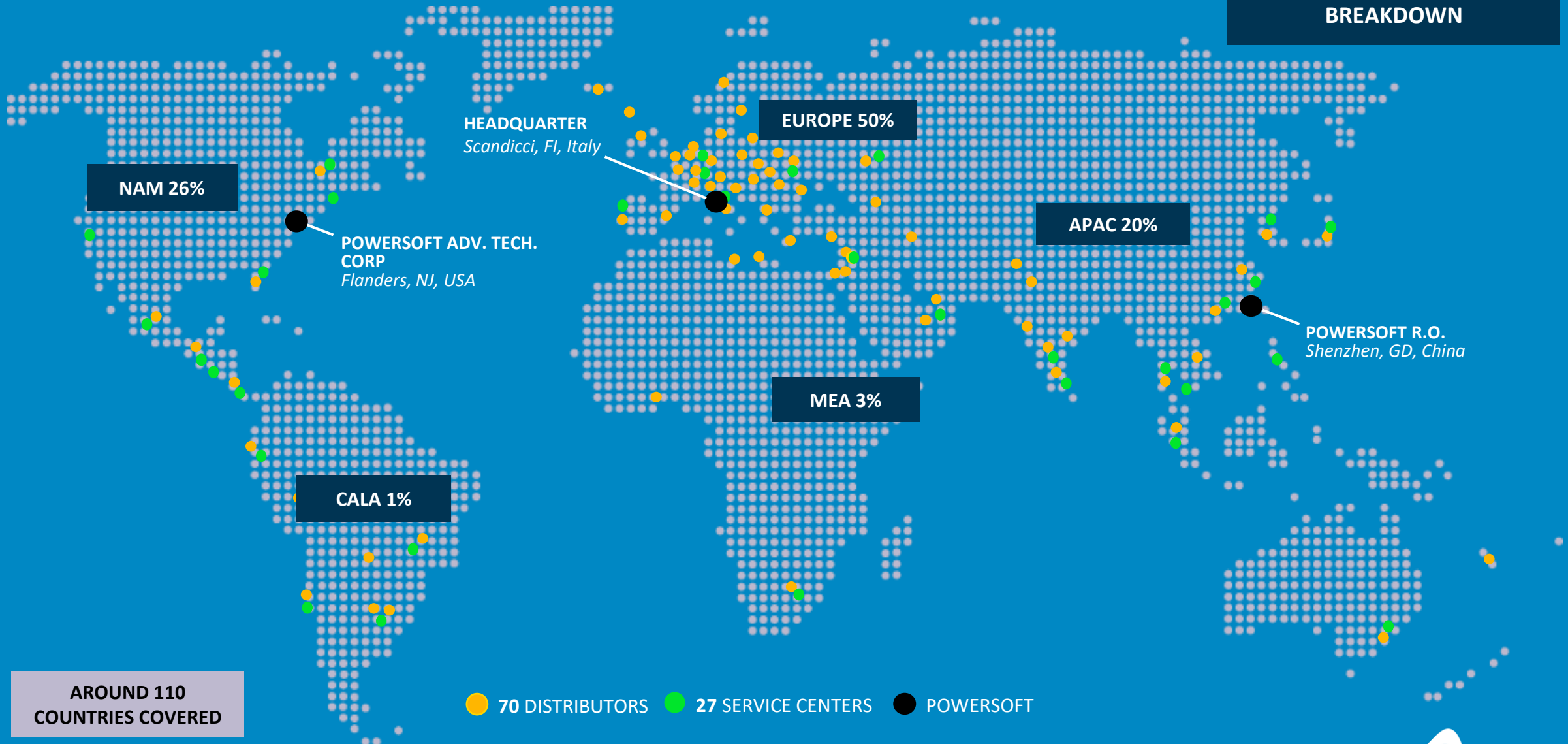

AROUND 110
COUNTRIES COVERED



DIVERSIFIED AND EFFICIENT BUSINESS MODEL

- **Internal «Lean» Production:** fully operational N° 5 lines (7 by YE)
- **ERP/MRP (Oracle):** strengthened and fully operational
- **4 main suppliers** fully certified

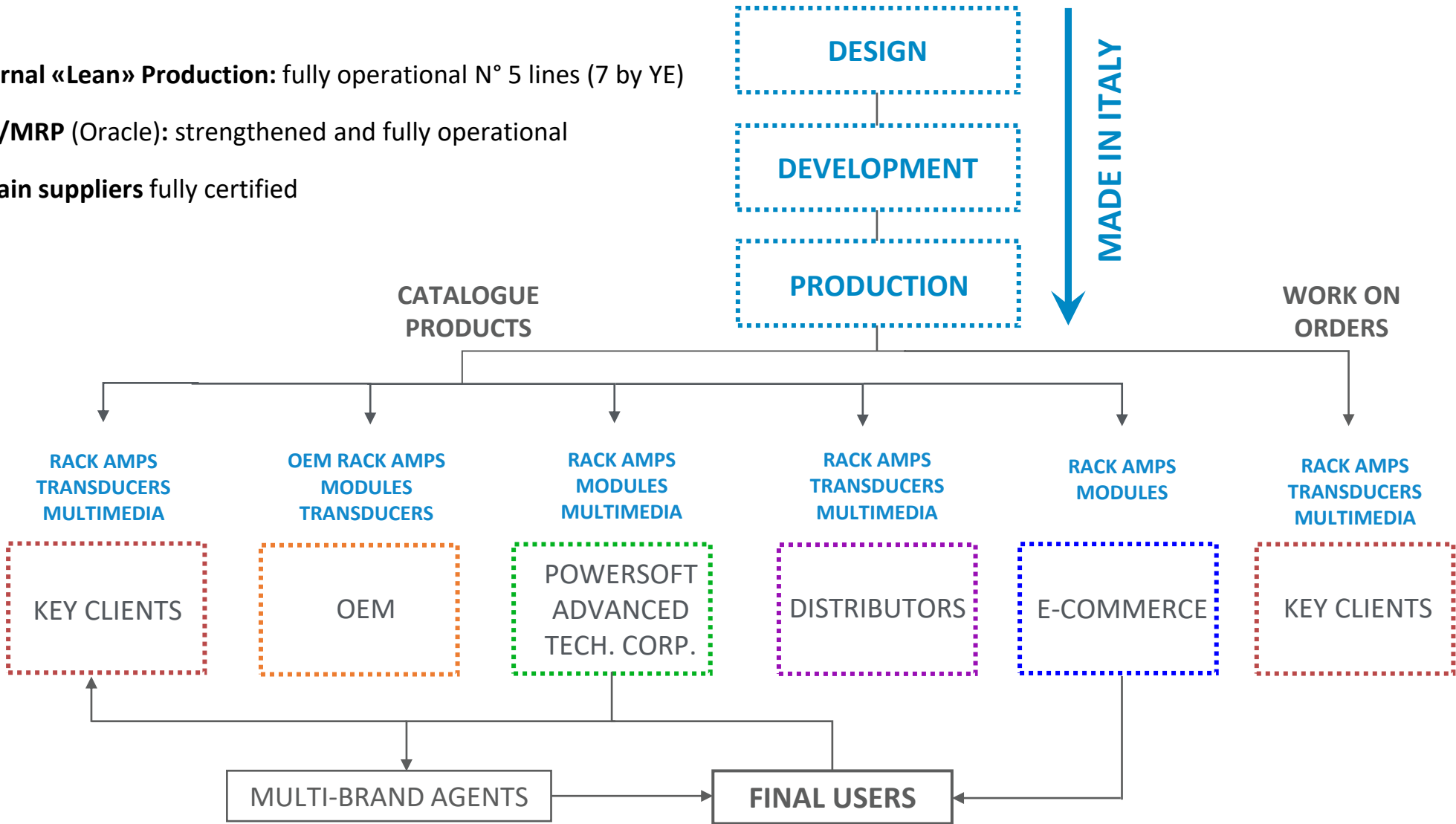

MARKET TREND & STRATEGY



RACK AMPLIFIER MARKET: INTERESTING RECOVERY PROSPECTS

- **Powersoft outperforming vs market average in 2020**
- **Market growing high single digit 2020-25**, Touring expected to gradually recover
- **Installed business remains the strongest** and most resilient, with relevant acceleration of technology adoption

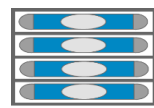

RACK AMPLIFIER

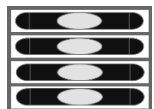

OEM RACK AMPLIFIER

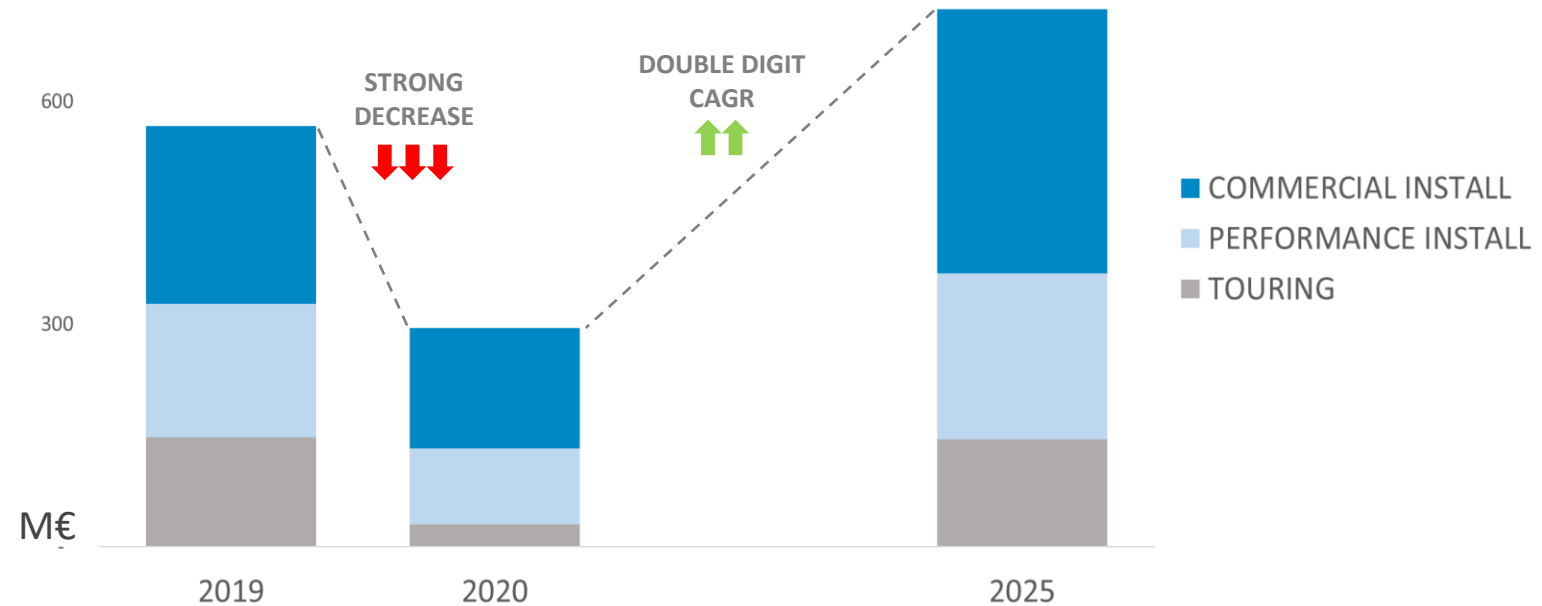

Data source: Powersoft elaboration based on primary research panels



A VERY FRAGMENTED MARKET WITH ROOM FOR CONSOLIDATION

Main market players for company size and level of vertical integration of products and / or offered services

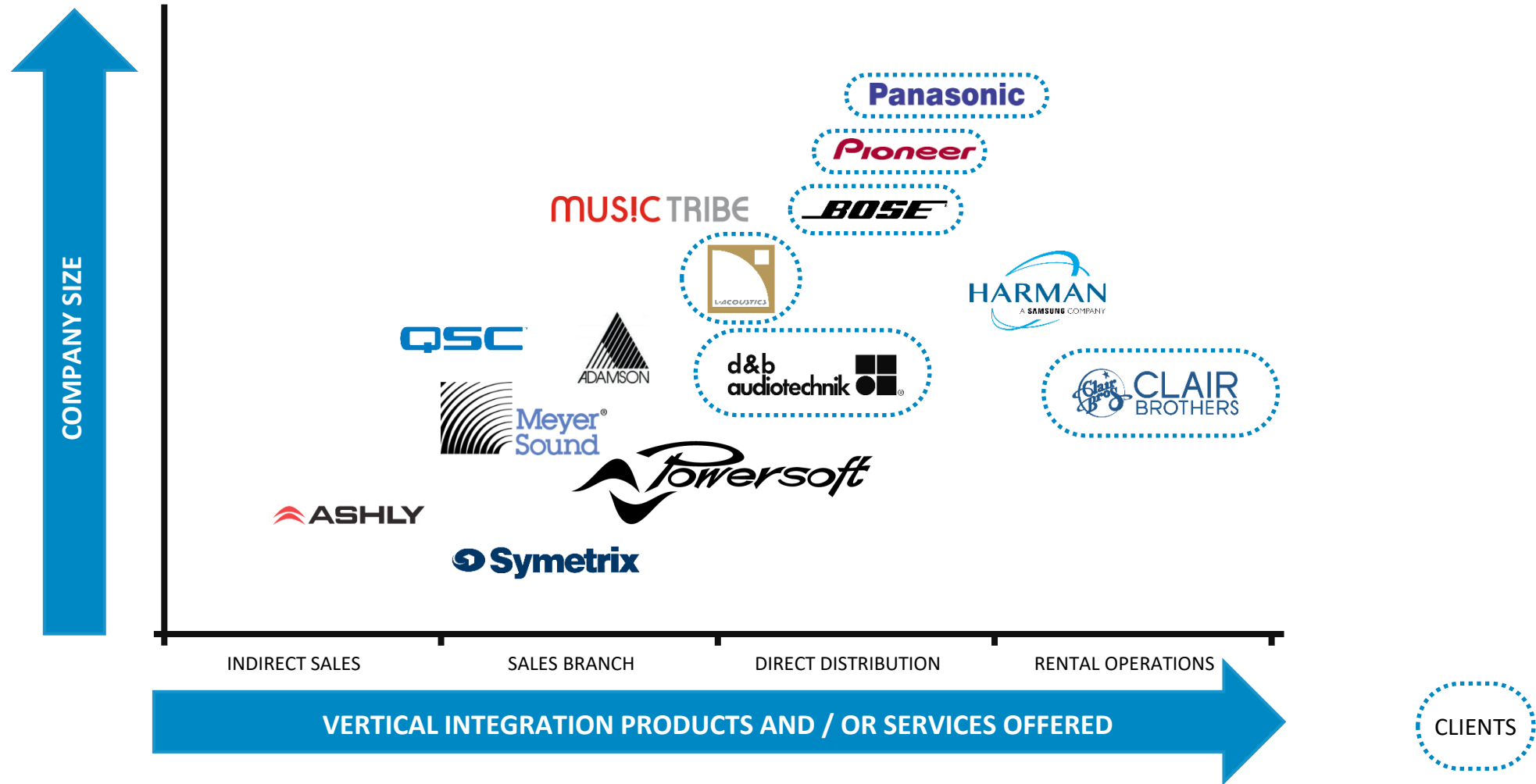

Data source: Powersoft elaboration based on primary research panels



GROWTH DRIVERS: THREE PILLARS STRATEGY

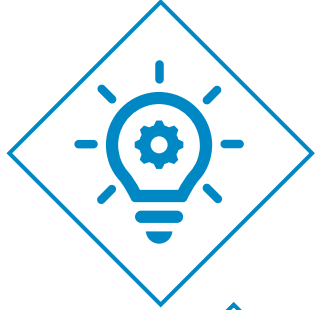

FROM PRODUCT COMPANY TO SOLUTION PROVIDER



MOVING TOWARDS A TRUE MULTINATIONAL GROUP



FOCUS ON INNOVATION AND NEW TECHNOLOGIES



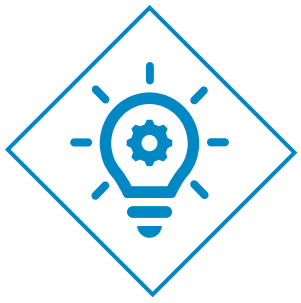

GROWTH DRIVERS: FROM PRODUCT COMPANY TO SOLUTION PROVIDER

STRATEGY

Focus on **proprietary solutions** designed for **specific target proAudio applications** suitable for **installed vertical markets**:

- **Hospitality**
- **Retail**
- **Higher Education**
- **Houses of Worship**
- **Venues**

Launch of value added and software-based services with cloud-based features to exploit **upselling/cross-selling potential**

ACTION

- **Akira Mochimaru** as new Global Marketing Director, previous General Manager for Bose Professional
- **Leverage company's WW presence** by partnerships with WW Key Accounts
- **New distribution channels:** E-commerce for B2B
- **New Salesforce CRM platform** to improve process automation
- **New products roadmap** to fulfil Powersoft offer
- **IoT & Cloud based services**

Dynamic Music Distribution

High-quality music distribution in multi-zone/source applications



Smart Cities

Connecting city and people through DEVA, a device that integrates multiple data gathering accessories





GROWTH DRIVERS: MOVING TOWARDS A TRUE MULTINATIONAL GROUP



USA

Boost presence in **US, Canada and Latin America** market*:

- **Strengthen US headquarter** by hiring new management, operational and sales staff
- **Focus on key clients** with dedicated sales force



CHINA

Presence strengthened in **China***:

- **Opened a local office** with new professionals to strengthen the **direct commercial presence**, alongside the local distributor and the key clients



EMEA

Consolidate Leadership in **EMEA**:

- **Widen presence** through additional distributors in strong potential markets as **Italy, France, Greece, Denmark, Norway and Sweden**
- **Partnership with strategic players** (ie Holoplot) to enter new markets

*China + US expected to be accounting **over 40%** of the total Professional Amplifier market by 2025.





GROWTH DRIVERS: FOCUS ON INNOVATION AND NEW TECHNOLOGIES



Ideofarm

Powersoft's own **growth accelerator** to support **new projects** and **innovative technologies**



Powersoft's **Trademark** which identifies **environmental friendly products**



Powersoft is the winner of the **Corporate & Social Responsibility Awards 2021**

INNOVATIONS

High entry barriers

- Top level R&D laboratory
- More than 30 international patents
- Many trademarks registered in over 30 countries
- **Innovative SME** (certified in the Italian Innovators public register)

High Energy Efficiency

- Environmentally friend products
- Small sizes, huge power

ADDED VALUE SERVICES

My Powersoft In Cloud Platform



KEY TAKEAWAYS

- Accelerated positioning **from Product Company to Solution Provider**
- **Faster growth** and **strong competitive positioning** thanks to **R&D investments** in **product innovation** and **offering expansion**
- **Improving market share in US and in China** by strengthening traditional sales channels and the development of new ones
- **Partnerships with industry players** and **opportunities** for long-term organic growth
- **Large install projects** and **audio immersive venues**: potential add on
- Using **M&A** to accelerate our **strategy implementation**
- The **strong order intake and backlog in all geographical areas**, driven by reference market recovery and supply shortage, **improve visibility going forward**





STRONG EQUITY STORY BACKED BY SOLID FINANCIALS

FINANCIAL HIGHLIGHTS

REVENUES €/M

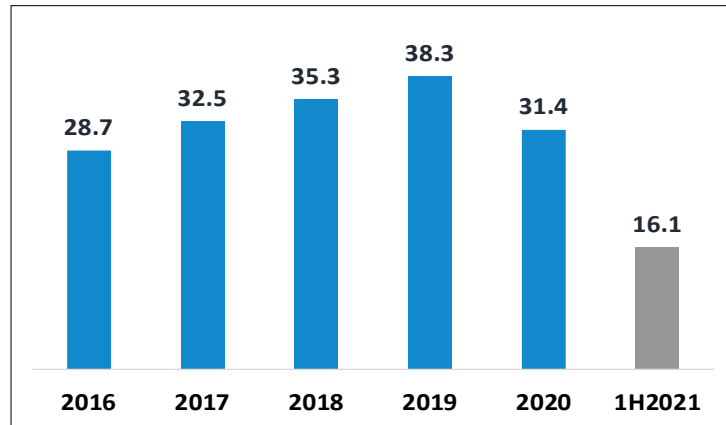

EBITDA €/M

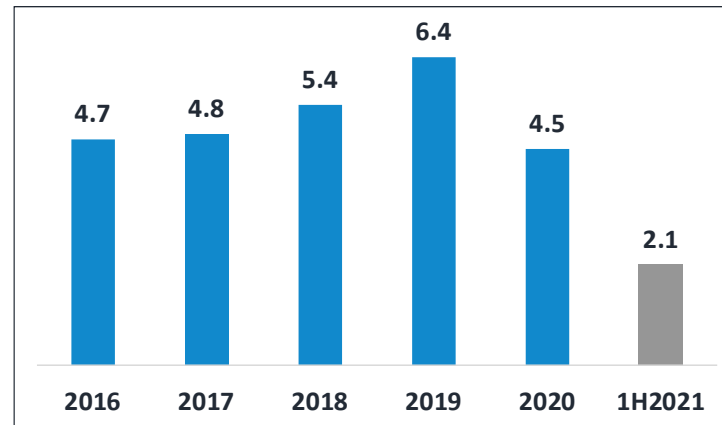

EBIT €/M

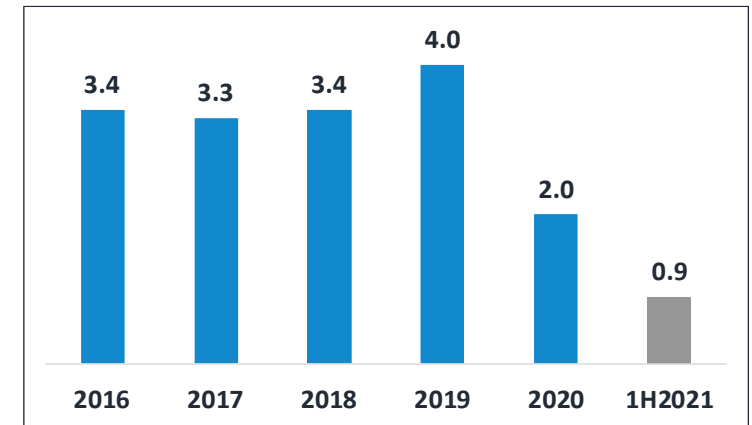

A solid equity story and sound financials, which allows the company to face, with flexibility and speed, the changing commercial and industrial needs, the current pandemia and growth goals

NET PROFIT €/M

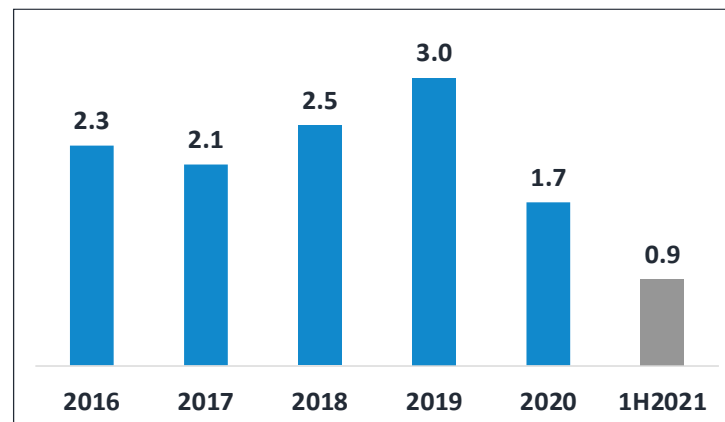

NFP (CASH) €/M

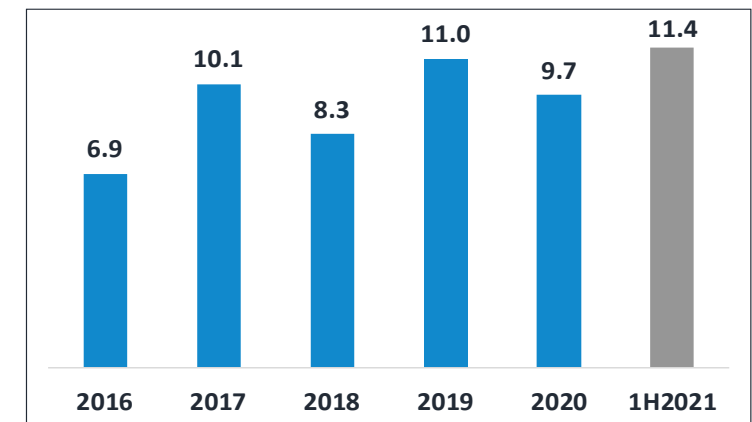

STRONG GROWTH RECORDED IN H1 2021

REVENUES €/M

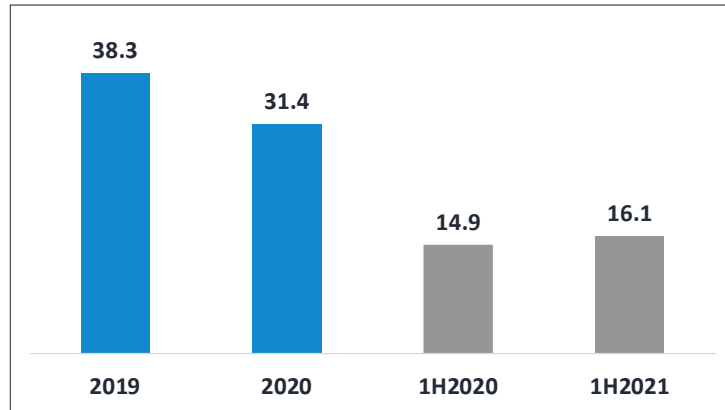

EBITDA €/M

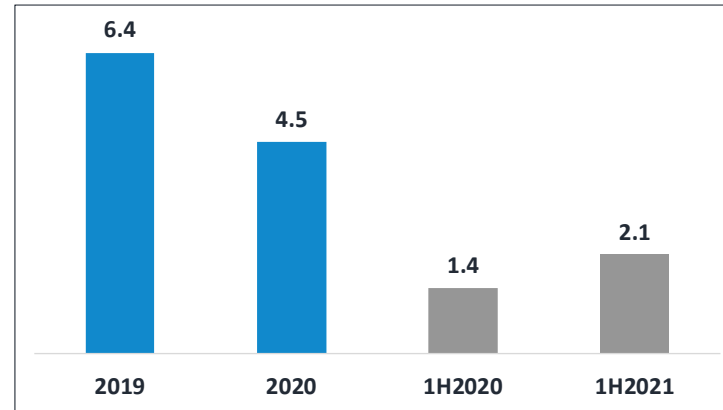

NET PROFIT €/M

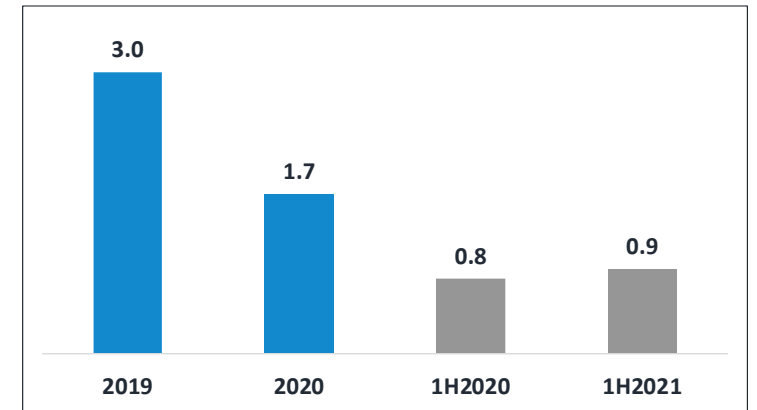

- **Total Revenues at €16.1 M, +8.6% YoY**
- **Sales Revenues at to €15.6 M +10.5% YoY**
- Signs of **partial recovery of the reference market** confirmed
- **Solid order book** sustains growth

EBITDA at €2.1 M, + 45.4% YoY & EBITDA margin at 13.4%

Reduction in operating costs:

- Personnel costs up 8%
- Commercial expenses down 54%

R&D investments at €1.3 M, including €0.6 M of capitalized costs

Net Profit at €1 M, +7.5% vs € 0.8 M in H12020 with an incidence on turnover of 5.8%



SOUND BALANCE SHEET

NET WORKING CAPITAL €/M

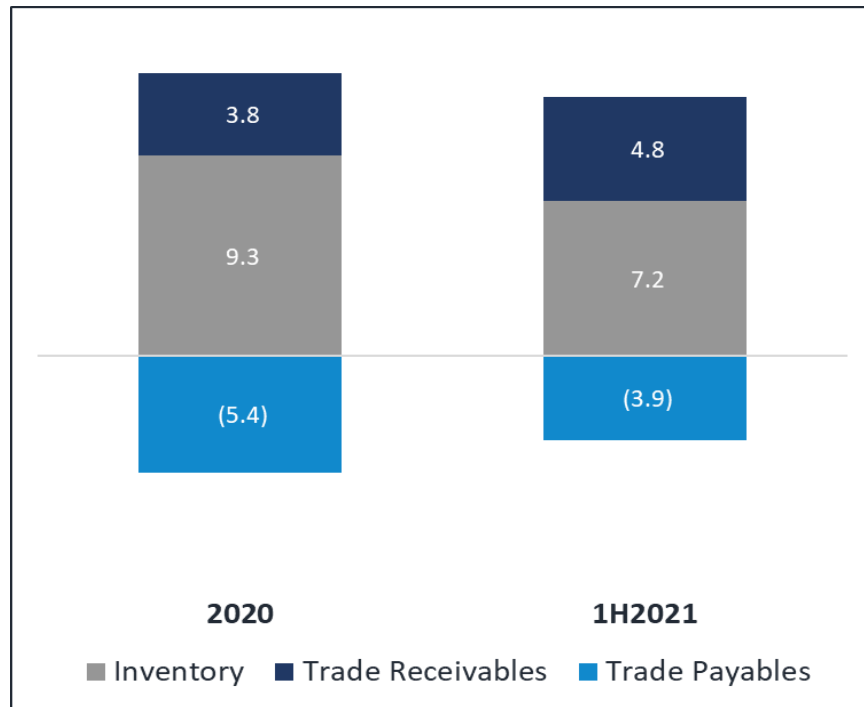

NET FINANCIAL POSITION €/K

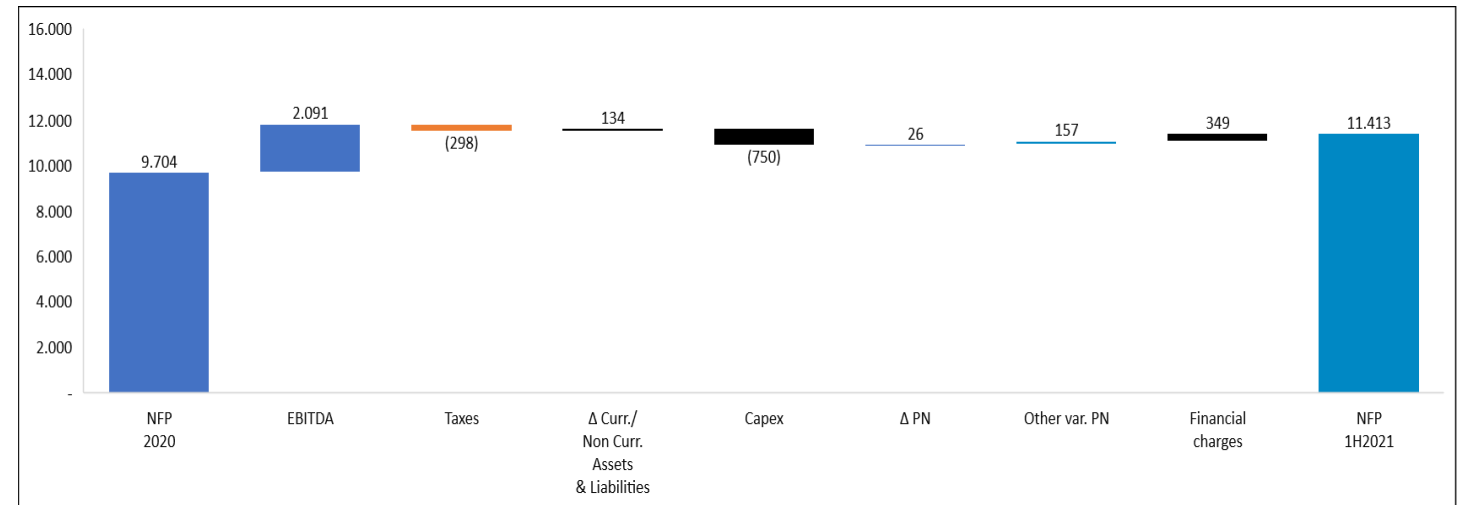

Net Working Capital down to € 8.5 M vs 31 December 2020 mainly due to **improvement in trade payables** owed to suppliers, only partially offset by the **increase in trade receivables** and a **reduction in inventories** resulting from careful management of stocks

NFP positive (Net Cash) for **€11.4 M** as results of Cash for €12.5 M and debt for leasing for € 1.1 M (IFRS 16 accounting)



The background of the entire page is a wide-angle photograph of a large church interior. The sanctuary is filled with a large congregation seated in wooden pews. At the front of the church, there is a stage with a large wooden cross on the wall behind it. Three large video screens are positioned across the stage, each displaying a live broadcast of a man in a suit speaking at a podium. The ceiling is high with recessed lighting and several large black stage lights are suspended from it.

APPENDIX

GOVERNANCE

BOARD OF DIRECTORS

 Carlo Lastrucci Chairman	 Luca Lastrucci CEO	 Claudio Lastrucci Director	 Antonio Peruch Director
 Luca Giorgi Director	 Paolo Blasi Independent Director	 Lorenzo Lepri Non-executive Director	

STOCK FIGURES

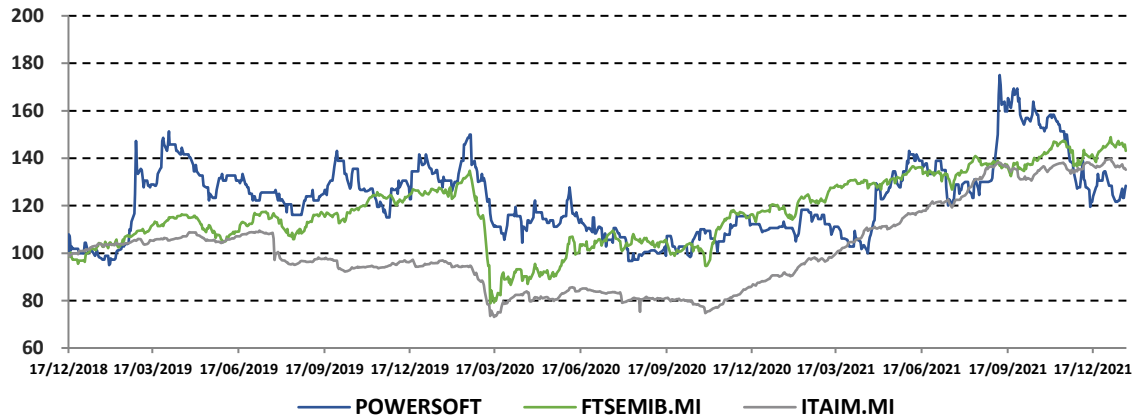

IPO: 17/12/2018

Shares: 11,385,292

Market: Euronext Growth Milan

Price (21/01/2022): €4.62

Market Cap (21/01/2022): €52.60M

Average Daily Volume*: 7.6K

BOARD OF STATUTORY AUDITORS

 Luigi Fazzini Chairman	 Federica Menichetti Standing Statutory Auditor
 Carlo Consigli Standing Statutory Auditor	 Paolo Limberti Alternate Statutory Auditor
 Massimiliano Manfredi Alternate Statutory Auditor	

AUDIT FIRM



SHAREHOLDINGS AND GROUP ORGANIZATION CHART

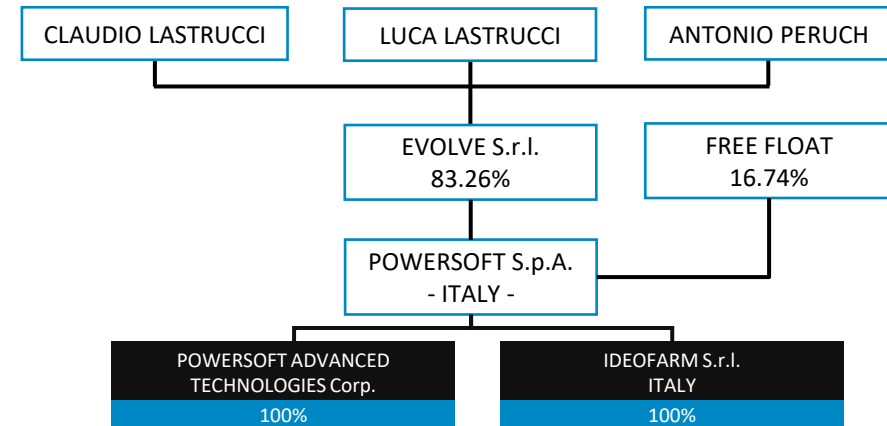

MARKET SETTER OF UNRIVALLED CUTTING-HEDGE PRODUCTS

SAFETY MULTIMEDIA DEVICES



DEVA

CONTROLLER



WM TOUCH

TRANSDUCERS



IPALMOD



M-FORCE



M-DRIVE



MOVER

RACK AMPLIFIERS



Q SERIES/D SERIES*



DUECANALI SERIES



OTTOCANALI SERIES



MEZZO SERIES



QUATTROCANALI SERIES



TTM



DIGAM 3000*



K SERIES



M SERIES



X SERIES



T SERIES

AMPLIFICATION MODULES



DIGIMOD



DIGIMOD PFC



D-CELL 504



DIGIMOD PFC2/PFC4



DIGIMOD IS



LITEMOD



MINIMOD



LOTO

1995-2003

2004-2009

2010-2013

2014-2019

2020-2021 →



ACTIONS AFTER COVID-19

- Acceleration of the **transformation process to system solution**
- Focus on some **vertical market channels**
- **Development of products and applications** for install applications
- Revision of some **internal processes and logistics**
- Long-term procurement and **production planning** to respond to component shortage
- Introduction of **new tools (CRM, Cloud, ...)**
- Revision of **contracts with suppliers**
- **Revision of organization chart** and insertion of some strategic figures
- Focus on **strategic geographical areas**
- Opening of **new sales channels** (e-commerce and services)
- **Revision of classes of service** for the sale of some products



MUSIC CLUB SYSTEM

CHALLENGE:

Open-air nightclub with the requirement to complete the project in 23 days.

SOLUTION:

9x **X4 DSP + ETH** to save on power consumption and gain amplification output.

RESULT:

Powersoft provided the most cost-efficient power solution per channel, with much simpler configuration requirements than competing products.

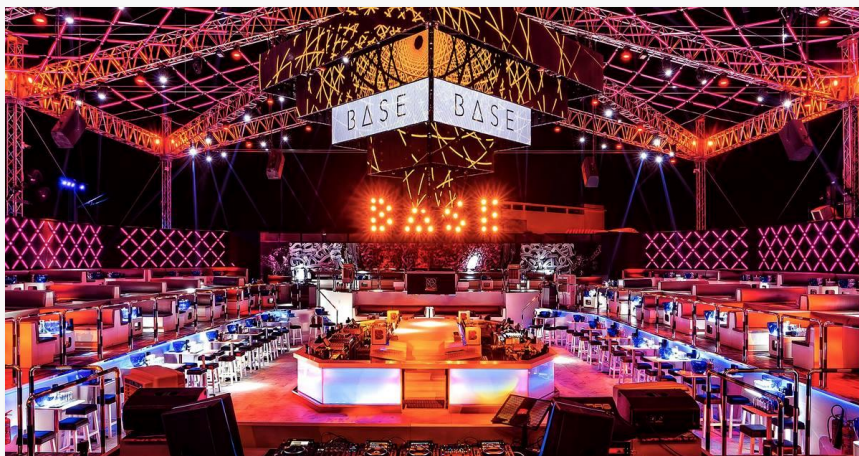

BASE NIGHTCLUB
DUBAI, UAE



STADIUM SYSTEM

CHALLENGE:

To serve the 59.000-seat stadium with a pristine and broadcast quality sound reinforcement system.

SOLUTION:

4x **Ottocanali 4K4** and 14x **Ottocanali 12K4** taking analogue feeds from Symetrix matrix router's Dante extension cards.

RESULT:

"When people come to this stadium, they get a real show, both visually and sonically. The result is a great installation for football fans which will resonate in the years to come."

- Nicolas Houel,
Technical Manager at OL Images



PARC OLYMPIQUE LYONNAIS STADIUM
LYON, FR



CULTURAL CENTRE

CHALLENGE:

To deliver a high-quality sound system for multi-purpose spaces with a dedicated platform for control and monitoring.

SOLUTION:

Quattrocanali DSP+D and **Duecanali DSP+D**

RESULT:

Customer satisfaction due to amplifier's ease of use and reliability.



HANAHOLMEN
ESPOO, FI

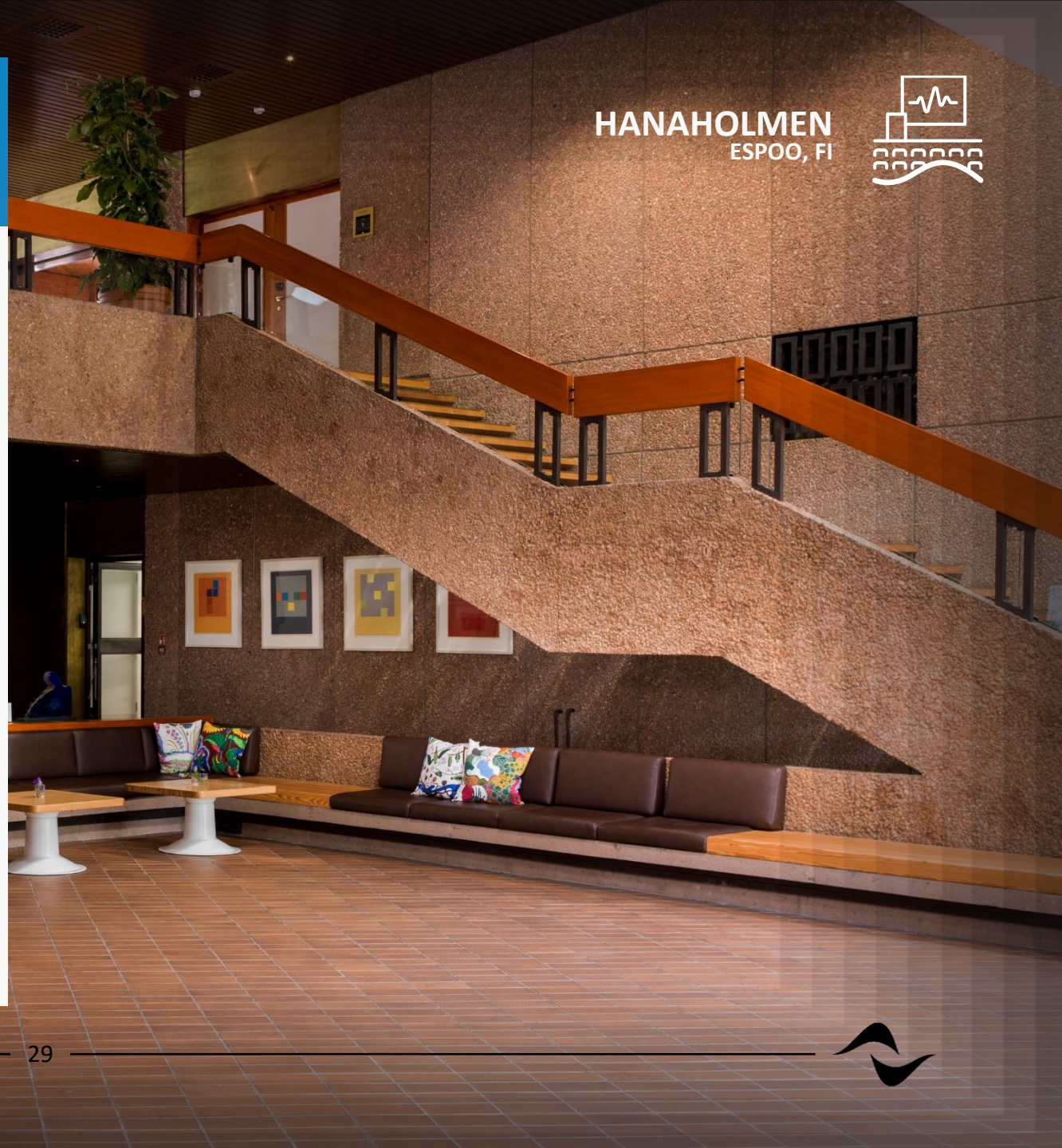

WORK SPACE SYSTEM

CHALLENGE:

A new system for Cross Campus co-working space, to be as networked and automated as possible, in such a way as not to require having a designated sound engineer present for the vast majority of events.

SOLUTION:

2x **Ottocanali DSP+D**, full system tuning with ArmoniaPlus, Dante connectivity and Symetrix integration.

RESULT:

“Powersoft is the only amp manufacturer that would have allowed me to provide the network and DSP functionality this job required while maintaining a healthy, great sounding system.”

- Matt Grossman,
Hollywood Sound Systems



CROSS CAMPUS
LOS ANGELES, USA

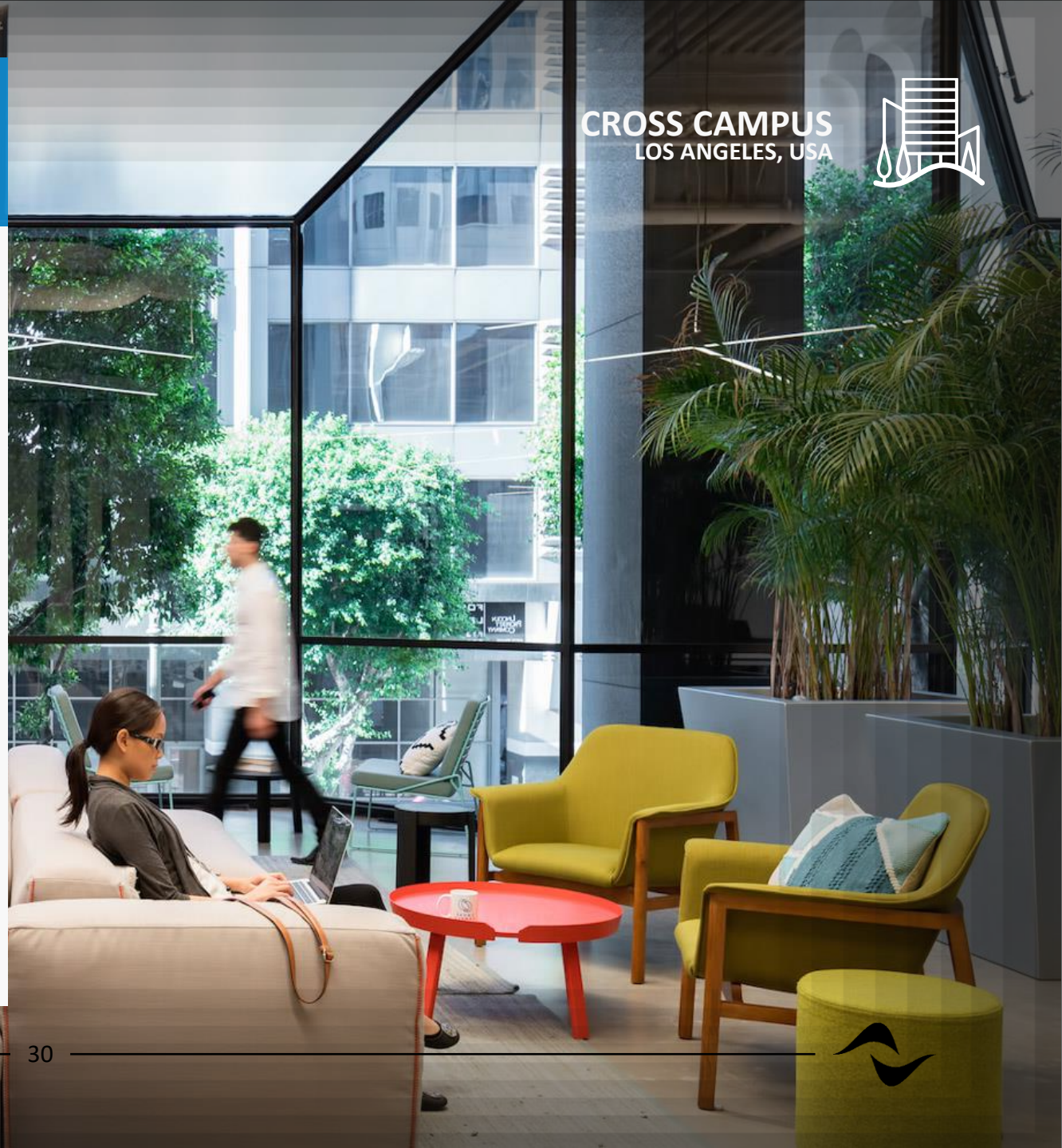

SHOPPING CENTRE SYSTEM

CHALLENGE:

A competitive Dante enabled solution for a combination of Hi and Lo-Z speakers distributed in different zones.

SOLUTION:

4x **Ottocanali DSP+D** and 2x **Quattrocanali DSP+D** with full Dante-Symetrix integration.

RESULT:

Flawless system performance and end customer satisfaction.

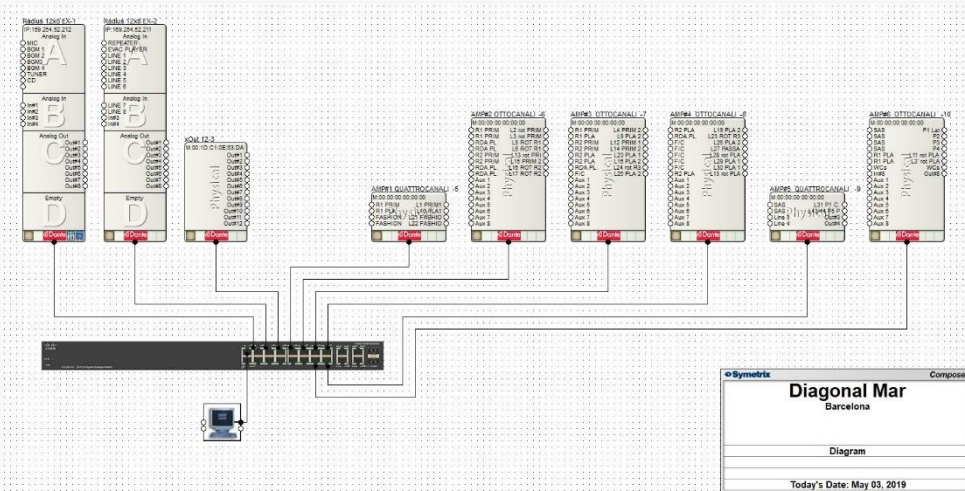

DIAGONAL MAR SHOPPING CENTRE
BARCELONA, ES



RESTAURANT SYSTEM

CHALLENGE:

A reliable and efficient system for background music, night after night. To reduce rack space and installation costs.

SOLUTION:

5x **Quattrocanali** units to replace 12x 2-channel amplifiers mixing Lo-Z and 70-Volt distributed line loads.

RESULT:

Reliable and high-power system with zero service required. Saving on racks, cabling and operational costs.



YARD HOUSE RESTAURANT
DENVER, USA



STADIUM SYSTEM

CHALLENGE:

To provide an amplification solution for the 30,000-seat arena, with low power consumption requirements and low heat dispersion, due to high summer temperatures.

SOLUTION:

4x **Ottocanali 8K4** to replace 12x 3RU pre-existing amplifiers.

RESULT:

"These amplifiers hit a lot harder than others on the market.

The sound and clarity was amazing. One of the first comments came from one of the executives asking if we had installed subwoofers in the system, which of course, we hadn't."

- Nathan Barlow,
Pro AV & Electronics



UNIVERSITY OF NEVADA - MACKAY STADIUM
RENO - NV, USA



HOTEL SYSTEM

CHALLENGE:

A reliable and efficient system to cover background music night after night, while providing sufficient power and headroom for volume boost in DJ nights and special events.

SOLUTION:

1x **Ottocanali 4K4** for the open-air lounge, and 1x **M30D** and 1x **4K4 Ottocanali** and for the penthouse hi-fi sound system.

RESULT:

“The sound quality of Powersoft is second to none, but we also choose Powersoft because of the consistency and reliability”



NAUTILUS HOTEL
MIAMI, USA



DISCLAIMER

“This Presentation contains certain forward-looking statements. Forward-looking statements concern future circumstances and results and other statements that are not historical facts, sometimes identified by the words "believes," "expects," "predicts," "intends," "projects," "plans," "estimates," "aims," "foresees," "anticipates," "targets," and similar expressions. The forward-looking statements contained in this Presentation, including assumptions, opinions and views of Powersoft S.p.A. (“**Powersoft**” or the “**Company**”) or cited from third party sources, are solely opinions and forecasts reflecting current views with respect to future events and plans, estimates, projections and expectations which are uncertain and subject to risks. Market data used in this Presentation not attributed to a specific source are estimates of the Company and have not been independently verified. These statements are based on certain assumptions that, although reasonable at this time, may prove to be erroneous. By their nature, forward-looking statements involve a number of risks, uncertainties and assumptions that could cause actual results or events to differ materially from those expressed or implied by the forward-looking statements. If certain risks and uncertainties materialize, or if certain underlying assumptions prove incorrect, the Company may not be able to achieve its financial targets and strategic objectives. A multitude of factors which are in some cases beyond the Company’s control can cause actual events to differ significantly from any anticipated development. Forward-looking statements contained in this Presentation regarding past trends or activities should not be taken as a representation that such trends or activities will continue in the future. No one undertakes any obligation to update or revise any forward-looking statements, whether as a result of new information, future events or otherwise. Market data used in this Presentation not attributed to a specific source are estimates of the Company and have not been independently verified. Forward-looking statements speak only as of the date of this Presentation and are subject to change without notice. No representations or warranties, express or implied, are given as to the achievement or reasonableness of, and no reliance should be placed on, any forward-looking statements, including (but not limited to) any projections, estimates, forecasts or targets contained herein. Powersoft does not undertake to provide any additional information or to remedy any omissions in or from this Presentation. Powersoft does not intend, and does not assume any obligation, to update industry information or forward-looking statements set forth in this Presentation. This presentation does not constitute a recommendation regarding the securities of the Company.

This Presentation is not an offer, or a solicitation of an offer, to buy, sell or exchange any securities in Italy, pursuant to Section 1, letter (t) and letter (v) of Legislative Decree no. 58 of February 24, 1998, or in any other country or state and is not a prospectus or an offer document within the meaning of Italian laws and regulations.”





Powersoft S.p.A.

Via Enrico Conti,5
50018 Scandicci

 www.powersoft.com



Euronext Growth Advisor

Banca Finnat
+39 39 06 69933215

Specialist

Banca Profilo S.p.A.
+39 02 584081

Corporate Broker

Alantra Capital Markets
+39 02 63671601



IR Manager

Massimo Ghedini
ir@powersoft.com
Ph. +39 055 7350230

IR Advisor

Vincenza Colucci – **CDR Communication**
vincenza.colucci@cdr-communication.it
M. +39 335 6909547
Giulia Loria - **CDR Communication**
M. +39 329 0916184



The information contained in these documents is confidential and only for the information of the intended recipient and may not be used, published or redistributed without the prior written consent of Powersoft S.p.A. All forecasts included in this document are subject to risks and uncertainties of Powersoft itself and of markets. All forecasts are based on currently available information and reflect our management expectations. All forecasts reflect market parameters, assumptions and other fundamentals which could change and therefore influence the future results. All the forecasts are based on an hypothesis of organic growth and commercial and regulatory stability.

